

ALO 1

MAIN CHARACTERISTICS

Applications	Wide area lighting and sports facilities.
Optic	SP15 / SP25 / SP40 / SP55: Symmetrical optic for projection. AM10 / AN10 / AW10 / ASM / ASW / A25: Asymmetrical optic for projection. Colour temperature: 5700K, CRI ≥ 70 (CRI 80, CRI 90 optional) 4000K, 3000K, CRI ≥ 70 optional LED source efficiency: 165 lm/W @ 350mA, Tj=85°C, 5700K
Insulation class	I
Protection degree	IP66 IK08 total
Dimensions	See the drawing
Weight	max 12.5 kg (excluded gear tray)
Exposed surface	Side: 0.026 m ² – Top: 0.15 m ² SCx: 0.13 m ²
Mounting	Installation with C bracket or MICROMOOVER.
Tilt Angle	C bracket: -90° ÷ +90° on horizontal plane with steps graduated in 5° controlled steps. Micro-adjustment with slots ±2.5° (0.5° step) for intermediate values to the main adjustment. MICROMOOVER: +20° ÷ +75° on horizontal plane. Micro-adjustment 0/+10° for intermediate values to the main setting. Adjustment on vertical axis: ±180°.
Gear tray	Remote. (Power supply size 335x144mm H=60mm - Weight: 3,4 kg). Optional: mounting over luminaire body with integrated flanges (only with C bracket version).
Operating temp.	-40°C / +50°C
Storage temperature	-40°C / +80°C
Main reference standards	EN 60598-1, EN 60598-2-3, EN 60598-2-5, IEC 62471, EN 55015, EN 61547, EN 61000-3-2, EN 61000-3-3



ELECTRICAL CHARACTERISTICS

Rated voltage	220÷480V 50/60Hz (Standard tolerance +/-10%, other voltages and tolerances upon request)
Power factor	>0,9 (at full load)
Flicker factor (FF)	< 3%
Mains connection	On terminal block for cables max. section 4mm ²
Surge protection	Up to 10kV
Control system (options)	F: Fixed power not dimmable. FLC: Constant light flux. DALI: Digital dimming interface DALI.
Optical unit lifetime (Tq=25°C, 800mA)	>50.000hr L80B10

MATERIALS

Fixing	Galvanized steel powder painted.
Body - Heat-sink	Die-cast aluminum UNI EN1706 powder painted.
Screen frame	Galvanized and painted steel with stainless steel springs.
Optic	Polycarbonate
Screen	Flat tempered glass, 5mm thickness high transparency.
Cable gland	Metallic M20 x 1.5 - IP68
Gasket	Silicone
Colour	Matt satin grey RAL 7004 - Cod. 7J

OPTIONAL

ES	External Shield – upward emission shield.
Red Dot Sight	Pointer for spot adjustments.
Power supply support	Support for integrated power supply mounting on floodlight (only with C bracket version).





DIMENSIONAL DRAWINGS

ALO with C bracket

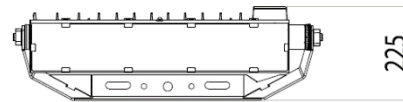
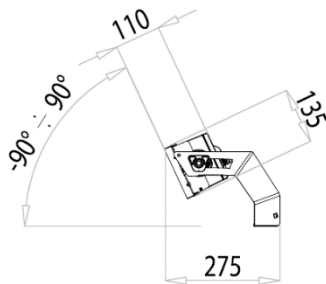
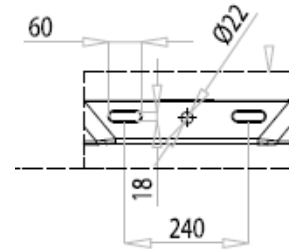
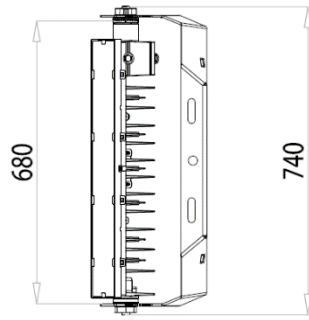

ALO with MICROMOVER

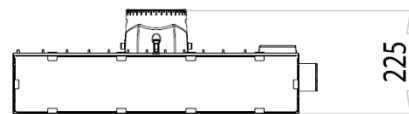
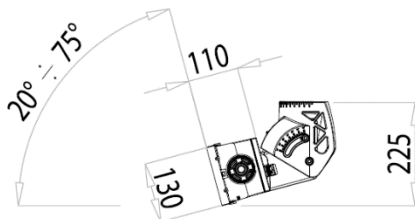
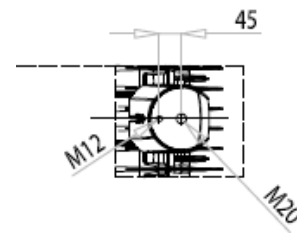
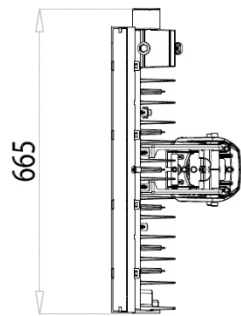

ALO 1 2AB10 SPORT LIGHTING – 7057 OT25

LUMINAIRE	OPTIC	LED CURRENT (mA)	RATED LUMINAIRE FLUX* (Tq=25°C, 5700K, lm)	RATED LUMINAIRE POWER* (Tq=25°C, Vin=230Vac, F, W)	LUMINAIRE EFFICACY (Tq=25°C, lm/W)	RATED LED FLUX* (Tj=85°C, 5700K, lm)	RATED LED POWER* (Tj=85°C, W)
ALO 1 2AB10 7057.350-22M OT25	SP15 SP25	350	33200	240	138	37700	210
ALO 1 2AB10 7057.400-22M OT25		400	37100	275	134	42700	245
ALO 1 2AB10 7057.450-22M OT25		450	41250	310	133	47600	275
ALO 1 2AB10 7057.500-22M OT25		500	45050	345	130	52400	310
ALO 1 2AB10 7057.550-22M OT25		550	49050	380	129	57100	345
ALO 1 2AB10 7057.600-22M OT25		600	52350	415	126	61700	380
ALO 1 2AB10 7057.650-22M OT25		650	55650	450	123	66200	415
ALO 1 2AB10 7057.700-22M OT25		700	58650	480	122	70700	450
ALO 1 2AB10 7057.750-22M OT25		750	61600	510	120	75100	485
ALO 1 2AB10 7057.800-22M OT25		800	63950	545	117	79400	520
ALO 1 2AB10 7057.350-22M OT25	SP40 SP55	350	30000	240	125	37700	210
ALO 1 2AB10 7057.400-22M OT25		400	33550	275	122	42700	245
ALO 1 2AB10 7057.450-22M OT25		450	37300	310	120	47600	275
ALO 1 2AB10 7057.500-22M OT25		500	40750	345	118	52400	310
ALO 1 2AB10 7057.550-22M OT25		550	44350	380	116	57100	345
ALO 1 2AB10 7057.600-22M OT25		600	47400	415	114	61700	380
ALO 1 2AB10 7057.650-22M OT25		650	50350	450	111	66200	415
ALO 1 2AB10 7057.700-22M OT25		700	53100	480	110	70700	450
ALO 1 2AB10 7057.750-22M OT25		750	55700	510	109	75100	485
ALO 1 2AB10 7057.800-22M OT25		800	57900	545	106	79400	520

*RATED LUMINAIRE FLUX / RATED LUMINAIRE POWER: Rated data obtained in laboratory.

*RATED LED FLUX / RATED LED POWER: Rated data extrapolated from LED manufacturer datasheet.

Values indicated in this technical sheet are to be considered rated values. Flux tolerance: $\pm 7\%$. Power tolerance: $\pm 10\%$.

The characteristics of the product listed above are subjected to change without notice.

Performance data for other operating temperatures (OT) and other combinations of CRI and CCT available on request.

There may be current limitations depending on the operating temperature. See dedicated section on following pages.

LUMINAIRE	OPTIC	LED CURRENT (mA)	RATED LUMINAIRE FLUX* (Tq=25°C, 5700K, lm)	RATED LUMINAIRE POWER* (Tq=25°C, Vin=230Vac, F, W)	LUMINAIRE EFFICACY (Tq=25°C, lm/W)	RATED LED FLUX* (Tj=85°C, 5700K, lm)	RATED LED POWER* (Tj=85°C, W)
ALO 1 2AB10 7057.350-22M OT25	A25 ASM	350	31850	240	132	37700	210
ALO 1 2AB10 7057.400-22M OT25		400	35600	275	129	42700	245
ALO 1 2AB10 7057.450-22M OT25		450	39600	310	127	47600	275
ALO 1 2AB10 7057.500-22M OT25		500	43250	345	125	52400	310
ALO 1 2AB10 7057.550-22M OT25		550	47050	380	123	57100	345
ALO 1 2AB10 7057.600-22M OT25		600	50300	415	121	61700	380
ALO 1 2AB10 7057.650-22M OT25		650	53400	450	118	66200	415
ALO 1 2AB10 7057.700-22M OT25		700	56350	480	117	70700	450
ALO 1 2AB10 7057.750-22M OT25		750	59100	510	115	75100	485
ALO 1 2AB10 7057.350-22M ES OT25		A25 ASM	350	30250	240	126	37700
ALO 1 2AB10 7057.400-22M ES OT25	400		33800	275	122	42700	245
ALO 1 2AB10 7057.450-22M ES OT25	450		37650	310	121	47600	275
ALO 1 2AB10 7057.500-22M ES OT25	500		41100	345	119	52400	310
ALO 1 2AB10 7057.550-22M ES OT25	550		44750	380	117	57100	345
ALO 1 2AB10 7057.600-22M ES OT25	600		47800	415	115	61700	380
ALO 1 2AB10 7057.650-22M ES OT25	650		50750	450	112	66200	415
ALO 1 2AB10 7057.700-22M ES OT25	700		53550	480	111	70700	450
ALO 1 2AB10 7057.750-22M ES OT25	750		56150	510	110	75100	485

*RATED LUMINAIRE FLUX / RATED LUMINAIRE POWER: Rated data obtained in laboratory.

*RATED LED FLUX / RATED LED POWER: Rated data extrapolated from LED manufacturer datasheet.

Values indicated in this technical sheet are to be considered rated values. Flux tolerance: ±7%. Power tolerance: ±10%.

The characteristics of the product listed above are subjected to change without notice.

Performance data for other operating temperatures (OT) and other combinations of CRI and CCT available on request.

There may be current limitations depending on the operating temperature. See dedicated section on following pages.

LUMINAIRE	OPTIC	LED CURRENT (mA)	RATED LUMINAIRE FLUX* (Tq=25°C, 5700K, lm)	RATED LUMINAIRE POWER* (Tq=25°C, Vin=230Vac, F, W)	LUMINAIRE EFFICACY (Tq=25°C, lm/W)	RATED LED FLUX* (Tj=85°C, 5700K, lm)	RATED LED POWER* (Tj=85°C, W)
ALO 1 2AB10 7057.350-22M OT25	ASW	350	31500	240	131	37700	210
ALO 1 2AB10 7057.400-22M OT25		400	35250	275	128	42700	245
ALO 1 2AB10 7057.450-22M OT25		450	39150	310	126	47600	275
ALO 1 2AB10 7057.500-22M OT25		500	42750	345	123	52400	310
ALO 1 2AB10 7057.550-22M OT25		550	46600	380	122	57100	345
ALO 1 2AB10 7057.600-22M OT25		600	49750	415	119	61700	380
ALO 1 2AB10 7057.650-22M OT25		650	52850	450	117	66200	415
ALO 1 2AB10 7057.700-22M OT25		700	55750	480	116	70700	450
ALO 1 2AB10 7057.750-22M OT25		750	58500	510	114	75100	485
ALO 1 2AB10 7057.350-22M ES OT25		ASW	350	29900	240	124	37700
ALO 1 2AB10 7057.400-22M ES OT25	400		33500	275	121	42700	245
ALO 1 2AB10 7057.450-22M ES OT25	450		37200	310	120	47600	275
ALO 1 2AB10 7057.500-22M ES OT25	500		40650	345	117	52400	310
ALO 1 2AB10 7057.550-22M ES OT25	550		44250	380	116	57100	345
ALO 1 2AB10 7057.600-22M ES OT25	600		47300	415	113	61700	380
ALO 1 2AB10 7057.650-22M ES OT25	650		50200	450	111	66200	415
ALO 1 2AB10 7057.700-22M ES OT25	700		52950	480	110	70700	450
ALO 1 2AB10 7057.750-22M ES OT25	750		55600	510	109	75100	485

*RATED LUMINAIRE FLUX / RATED LUMINAIRE POWER: Rated data obtained in laboratory.

*RATED LED FLUX / RATED LED POWER: Rated data extrapolated from LED manufacturer datasheet.

Values indicated in this technical sheet are to be considered rated values. Flux tolerance: $\pm 7\%$. Power tolerance: $\pm 10\%$.

The characteristics of the product listed above are subjected to change without notice.

Performance data for other operating temperatures (OT) and other combinations of CRI and CCT available on request.

There may be current limitations depending on the operating temperature. See dedicated section on following pages.

LUMINAIRE	OPTIC	LED CURRENT (mA)	RATED LUMINAIRE FLUX* (Tq=25°C, 5700K, lm)	RATED LUMINAIRE POWER* (Tq=25°C, Vin=230Vac, F, W)	LUMINAIRE EFFICACY (Tq=25°C, lm/W)	RATED LED FLUX* (Tj=85°C, 5700K, lm)	RATED LED POWER* (Tj=85°C, W)
ALO 1 2AB10 7057.350-22M OT25	AM10	350	30550	240	127	37700	210
ALO 1 2AB10 7057.400-22M OT25		400	34150	275	124	42700	245
ALO 1 2AB10 7057.450-22M OT25		450	37950	310	122	47600	275
ALO 1 2AB10 7057.500-22M OT25		500	41450	345	120	52400	310
ALO 1 2AB10 7057.550-22M OT25		550	45100	380	118	57100	345
ALO 1 2AB10 7057.600-22M OT25		600	48200	415	116	61700	380
ALO 1 2AB10 7057.650-22M OT25		650	51200	450	113	66200	415
ALO 1 2AB10 7057.700-22M OT25		700	54000	480	112	70700	450
ALO 1 2AB10 7057.750-22M OT25		750	56650	510	111	75100	485
ALO 1 2AB10 7057.350-22M ES OT25		AM10	350	28100	240	117	37700
ALO 1 2AB10 7057.400-22M ES OT25	400		31400	275	114	42700	245
ALO 1 2AB10 7057.450-22M ES OT25	450		34950	310	112	47600	275
ALO 1 2AB10 7057.500-22M ES OT25	500		38100	345	110	52400	310
ALO 1 2AB10 7057.550-22M ES OT25	550		41500	380	109	57100	345
ALO 1 2AB10 7057.600-22M ES OT25	600		44300	415	106	61700	380
ALO 1 2AB10 7057.650-22M ES OT25	650		47100	450	104	66200	415
ALO 1 2AB10 7057.700-22M ES OT25	700		49650	480	103	70700	450
ALO 1 2AB10 7057.750-22M ES OT25	750		52100	510	102	75100	485

*RATED LUMINAIRE FLUX / RATED LUMINAIRE POWER: Rated data obtained in laboratory.

*RATED LED FLUX / RATED LED POWER: Rated data extrapolated from LED manufacturer datasheet.

Values indicated in this technical sheet are to be considered rated values. Flux tolerance: $\pm 7\%$. Power tolerance: $\pm 10\%$.

The characteristics of the product listed above are subjected to change without notice.

Performance data for other operating temperatures (OT) and other combinations of CRI and CCT available on request.

There may be current limitations depending on the operating temperature. See dedicated section on following pages.

LUMINAIRE	OPTIC	LED CURRENT (mA)	RATED LUMINAIRE FLUX* (Tq=25°C, 5700K, lm)	RATED LUMINAIRE POWER* (Tq=25°C, Vin=230Vac, F, W)	LUMINAIRE EFFICACY (Tq=25°C, lm/W)	RATED LED FLUX* (Tj=85°C, 5700K, lm)	RATED LED POWER* (Tj=85°C, W)
ALO 1 2AB10 7057.350-22M OT25	AN10	350	30550	240	127	37700	210
ALO 1 2AB10 7057.400-22M OT25		400	34150	275	124	42700	245
ALO 1 2AB10 7057.450-22M OT25		450	37950	310	122	47600	275
ALO 1 2AB10 7057.500-22M OT25		500	41450	345	120	52400	310
ALO 1 2AB10 7057.550-22M OT25		550	45100	380	118	57100	345
ALO 1 2AB10 7057.600-22M OT25		600	48200	415	116	61700	380
ALO 1 2AB10 7057.650-22M OT25		650	51200	450	113	66200	415
ALO 1 2AB10 7057.700-22M OT25		700	54000	480	112	70700	450
ALO 1 2AB10 7057.750-22M OT25		750	56650	510	111	75100	485
ALO 1 2AB10 7057.350-22M ES OT25		AN10	350	29000	240	120	37700
ALO 1 2AB10 7057.400-22M ES OT25	400		32450	275	118	42700	245
ALO 1 2AB10 7057.450-22M ES OT25	450		36050	310	116	47600	275
ALO 1 2AB10 7057.500-22M ES OT25	500		39400	345	114	52400	310
ALO 1 2AB10 7057.550-22M ES OT25	550		42800	380	112	57100	345
ALO 1 2AB10 7057.600-22M ES OT25	600		45800	415	110	61700	380
ALO 1 2AB10 7057.650-22M ES OT25	650		48650	450	108	66200	415
ALO 1 2AB10 7057.700-22M ES OT25	700		51300	480	106	70700	450
ALO 1 2AB10 7057.750-22M ES OT25	750		53850	510	105	75100	485

*RATED LUMINAIRE FLUX / RATED LUMINAIRE POWER: Rated data obtained in laboratory.

*RATED LED FLUX / RATED LED POWER: Rated data extrapolated from LED manufacturer datasheet.

Values indicated in this technical sheet are to be considered rated values. Flux tolerance: $\pm 7\%$. Power tolerance: $\pm 10\%$.

The characteristics of the product listed above are subjected to change without notice.

Performance data for other operating temperatures (OT) and other combinations of CRI and CCT available on request.

There may be current limitations depending on the operating temperature. See dedicated section on following pages.

LUMINAIRE	OPTIC	LED CURRENT (mA)	RATED LUMINAIRE FLUX* (Tq=25°C, 5700K, lm)	RATED LUMINAIRE POWER* (Tq=25°C, Vin=230Vac, F, W)	LUMINAIRE EFFICACY (Tq=25°C, lm/W)	RATED LED FLUX* (Tj=85°C, 5700K, lm)	RATED LED POWER* (Tj=85°C, W)
ALO 1 2AB10 7057.350-22M OT25	AW10	350	30550	240	127	37700	210
ALO 1 2AB10 7057.400-22M OT25		400	34150	275	124	42700	245
ALO 1 2AB10 7057.450-22M OT25		450	37950	310	122	47600	275
ALO 1 2AB10 7057.500-22M OT25		500	41450	345	120	52400	310
ALO 1 2AB10 7057.550-22M OT25		550	45100	380	118	57100	345
ALO 1 2AB10 7057.600-22M OT25		600	48200	415	116	61700	380
ALO 1 2AB10 7057.650-22M OT25		650	51200	450	113	66200	415
ALO 1 2AB10 7057.700-22M OT25		700	54000	480	112	70700	450
ALO 1 2AB10 7057.750-22M OT25		750	56650	510	111	75100	485
ALO 1 2AB10 7057.350-22M ES OT25		AW10	350	28650	240	119	37700
ALO 1 2AB10 7057.400-22M ES OT25	400		32050	275	116	42700	245
ALO 1 2AB10 7057.450-22M ES OT25	450		35650	310	115	47600	275
ALO 1 2AB10 7057.500-22M ES OT25	500		38950	345	112	52400	310
ALO 1 2AB10 7057.550-22M ES OT25	550		42400	380	111	57100	345
ALO 1 2AB10 7057.600-22M ES OT25	600		45250	415	109	61700	380
ALO 1 2AB10 7057.650-22M ES OT25	650		48100	450	106	66200	415
ALO 1 2AB10 7057.700-22M ES OT25	700		50750	480	105	70700	450
ALO 1 2AB10 7057.750-22M ES OT25	750		53250	510	104	75100	485

*RATED LUMINAIRE FLUX / RATED LUMINAIRE POWER: Rated data obtained in laboratory.

*RATED LED FLUX / RATED LED POWER: Rated data extrapolated from LED manufacturer datasheet.

Values indicated in this technical sheet are to be considered rated values. Flux tolerance: $\pm 7\%$. Power tolerance: $\pm 10\%$.

The characteristics of the product listed above are subjected to change without notice.

Performance data for other operating temperatures (OT) and other combinations of CRI and CCT available on request.

There may be current limitations depending on the operating temperature. See dedicated section on following pages.

Temperature by Geographic Area

Geographic Area	Country	Hottest month Average Ta (°C)	Suggested OT (°C)	Geographic Area	Country	Hottest month Average Ta (°C)	Suggested OT (°C)
America	Argentina	28	30	EU	Austria	26	25
America	Brazil	28	30	EU	Bosnia Herzegovina	34	35
America	Canada	25	25	EU	Denmark	21	20
America	Chile	30	30	EU	Estonia	21	20
	Colombia	19	20	EU	Finland	20	20
America	Mexico	27	30	EU	France (Lyon)	28	30
America	Perù	27	30	EU	France (Marseille)	30	30
America	USA (Arizona)	40	40	EU	France (Parigi)	25	25
America	USA (New York)	29	30	EU	Germany	25	25
Asia/Oceania	Australia	27	30	EU	Greece	33	35
Asia/Oceania	South Korea	30	30	EU	Ireland	19	20
Asia/Oceania	Philippines	34	35	EU	Iceland	14	15
Asia/Oceania	Hong Kong	32	35	EU	Canary Islands	28	30
Asia/Oceania	India	36	35	EU	Italy	30	30
Asia/Oceania	Malaysia	33	35	EU	Liechtenstein	24	25
Asia/Oceania	New Zealand	23	25	EU	Lithuania	23	25
Asia/Oceania	Pakistan	34	35	EU	Luxembourg	24	25
Asia/Oceania	Russia	24	25	EU	Malta	32	35
Asia/Oceania	Singapore	32	35	EU	Norway	21	20
Asia/Oceania	Taiwan	34	35	EU	Netherlands	20	20
Asia/Oceania	Vietnam	34	35	EU	Poland	24	25
EMEA	Saudi Arabia	43	45	EU	Portugal	29	30
EMEA	Bahrain	39	40	EU	Czech Republic	25	25
EMEA	Egypt	35	35	EU	Romania	30	30
EMEA	Jordan	32	35	EU	Scotland	19	20
EMEA	Israel	30	30	EU	Slovenia	27	30
EMEA	Kuwait	46	50	EU	Spain (Madrid)	33	35
EMEA	Libanon	30	30	EU	Spain (Malaga)	31	30
EMEA	Morocco	27	30	EU	Spain (Barcelona)	32	35
EMEA	Oman	38	40	EU	Sweden (Goteborg)	21	20
EMEA	Qatar	42	45	EU	Sweden (Borlänge)	23	25
EMEA	UAE (Abu Dhabi)	40	40	EU	Switzerland	25	25
				EU	Turkey (Ankara)	31	30
				EU	Ukraine (Kiev)	26	25
				EU	UK	20	20

Maximum Current for Operating Temperature

SPORT LIGHTING - OUTDOOR							
Temperature (°C)	OT20	OT25	OT30	OT35	OT40	OT45	OT50
SPOT Optics Max. Current (mA)	800	800	800	750	700	650	600
Asymmetrical Optics Max. Current (mA)	750	750	700	650	600	550	500

SPORT LIGHTING - INDOOR						
Temperature (°C)	OT25	OT30	OT35	OT40	OT45	OT50
SPOT Optics Max. Current (mA)	750	750	700	650	600	550
Asymmetrical Optics Max. Current (mA)	650	650	600	550	500	450