

ALO

ALO 1

MAIN CHARACTERISTICS

Applications	Wide area lighting and sports facilities.
Optic	SP15 / SP25 / SP40 / SP55: Symmetrical optic for projection. AM10 / AN10 / AW10 / ASM / ASN / ASW / A25: Asymmetrical optic for projection. BAC: Bidirectional asymmetric optic for projection, central emission. BAR/BAL: Bidirectional asymmetric optic for projection, right/left emission. Colour temperature: 5700K, CRI ≥ 70 (CRI 80, CRI 90 optional) 4000K, 3000K, CRI ≥ 70 optional LED source efficiency: 165 lm/W @ 350mA, T _j =85°C, 5700K
Insulation class	I
Protection degree	IP66 IK08 total
Dimensions	See the drawing
Weight	max 12.5 kg (excluded gear tray)
Exposed surface	Side: 0.026 m ² – Top: 0.15 m ² SCx: 0.13 m ²
Mounting	Installation with C bracket or MICROMOOVER.
Tilt Angle	C bracket: -90° ÷ +90° on horizontal plane with steps graduated in 5° controlled steps. Micro-adjustment with slots ±2.5° (0.5° step) for intermediate values to the main adjustment. MICROMOOVER: +20° ÷ +75° on horizontal plane. Micro-adjustment 0/+10° for intermediate values to the main setting. Adjustment on vertical axis: ±180°.
Gear tray	Remote. (Power supply size 335x144mm H=60mm - Weight: 3,4 kg). Optional: mounting over luminaire body with integrated flanges (only with C bracket version).
Operating temp.	-40°C / +50°C
Storage temperature	-40°C / +80°C
Main reference standards	EN 60598-1, EN 60598-2-3, EN 60598-2-5, IEC 62471, EN 55015, EN 61547, EN 61000-3-2, EN 61000-3-3



ELECTRICAL CHARACTERISTICS

Rated voltage	220÷480V 50/60Hz (Standard tolerance +/-10%, other voltages and tolerances upon request)
Power factor	>0,9 (at full load)
Flicker factor (FF)	< 3%
Mains connection	On terminal block for cables max. section 4mm ²
Surge protection	Up to 10kV
Control system (options)	F: Fixed power not dimmable. FLC: Constant light flux. DALI: Digital dimming interface DALI.
Optical unit lifetime (T_q=25°C, 800mA)	>50.000hr L80B10

MATERIALS

Fixing	Galvanized steel powder painted.
Body - Heat-sink	Die-cast aluminum UNI EN1706 powder painted.
Screen frame	Galvanised and painted steel with stainless steel springs.
Optic	Polycarbonate
Screen	Flat tempered glass, 5mm thickness high transparency.
Cable gland	Metallic M20 x 1.5 - IP68
Gasket	Silicone
Colour	Matt satin grey RAL 7004 - Cod. 7J

OPTIONAL

ES	External Shield – upward emission shield.
Red Dot Sight	Pointer for spot adjustments.
Power supply support	Support for integrated power supply mounting on floodlight (only with C bracket version).



DIMENSIONAL DRAWINGS

ALO with C bracket

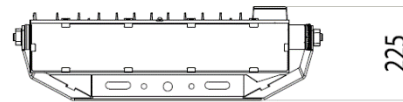
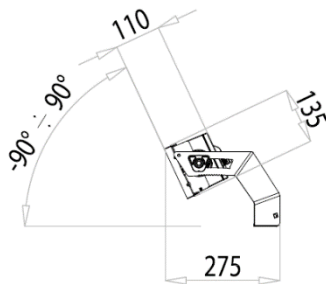
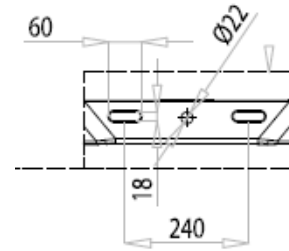
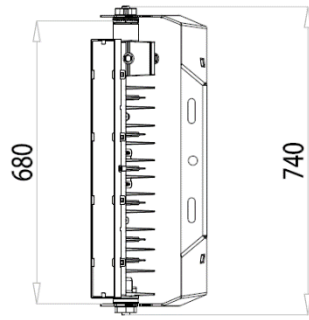

ALO with MICROMØVER

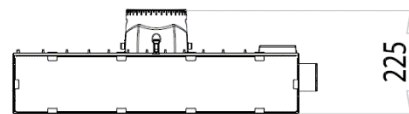
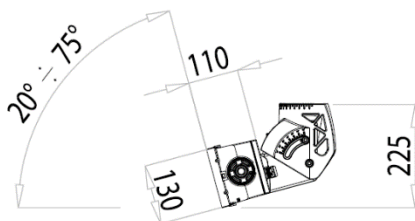
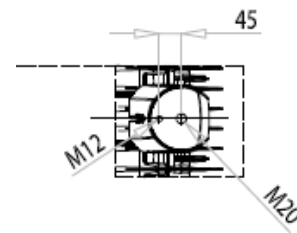
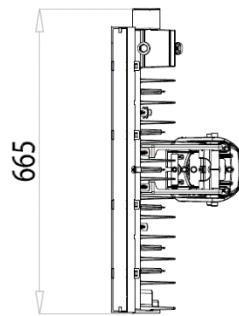

ALO 1 2AB10 SPORT LIGHTING – 7057 OT25

LUMINAIRE	OPTIC	LED CURRENT (mA)	RATED LUMINAIRE FLUX* (Tq=25°C, 5700K, lm)	RATED LUMINAIRE POWER* (Tq=25°C, Vin=230Vac, F, W)	LUMINAIRE EFFICACY (Tq=25°C, lm/W)	RATED LED FLUX* (Tj=85°C, 5700K, lm)	RATED LED POWER* (Tj=85°C, W)
ALO 1 2AB10 A25 7057.350-22M OT25	A25	350	32950	225	146.4	37700	210
ALO 1 2AB10 A25 7057.400-22M OT25	A25	400	37000	260	142.3	42700	245
ALO 1 2AB10 A25 7057.450-22M OT25	A25	450	40950	290	141.2	47600	275
ALO 1 2AB10 A25 7057.500-22M OT25	A25	500	44700	325	137.5	52400	310
ALO 1 2AB10 A25 7057.550-22M OT25	A25	550	48300	360	134.1	57100	345
ALO 1 2AB10 A25 7057.600-22M OT25	A25	600	51800	395	131.1	61700	380
ALO 1 2AB10 A25 7057.650-22M OT25	A25	650	55150	430	128.2	66200	415
ALO 1 2AB10 A25 7057.700-22M OT25	A25	700	58400	465	125.5	70700	450
ALO 1 2AB10 A25 7057.750-22M OT25	A25	750	61450	500	122.9	75100	485
ALO 1 2AB10 A25 7057.800-22M OT25	A25	800	64450	540	119.3	79400	520
ALO 1 2AB10 A25 7057.825-22M OT25	A25	825	65900	560	117.6	81500	535
ALO 1 2AB10 A25 7057.350-22M ES OT25	A25	350	31630	225	140.5	37700	210
ALO 1 2AB10 A25 7057.400-22M ES OT25	A25	400	35520	260	136.6	42700	245
ALO 1 2AB10 A25 7057.450-22M ES OT25	A25	450	39310	290	135.5	47600	275
ALO 1 2AB10 A25 7057.500-22M ES OT25	A25	500	42910	325	132	52400	310
ALO 1 2AB10 A25 7057.550-22M ES OT25	A25	550	46370	360	128.8	57100	345
ALO 1 2AB10 A25 7057.600-22M ES OT25	A25	600	49730	395	125.8	61700	380
ALO 1 2AB10 A25 7057.650-22M ES OT25	A25	650	52940	430	123.1	66200	415
ALO 1 2AB10 A25 7057.700-22M ES OT25	A25	700	56060	465	120.5	70700	450
ALO 1 2AB10 A25 7057.750-22M ES OT25	A25	750	58990	500	117.9	75100	485
ALO 1 2AB10 A25 7057.800-22M ES OT25	A25	800	61870	540	114.5	79400	520
ALO 1 2AB10 A25 7057.825-22M ES OT25	A25	825	63260	560	112.9	81500	535
ALO 1 2AB10 AM10 7057.350-22M OT25	AM10	350	32600	225	144.8	37700	210
ALO 1 2AB10 AM10 7057.400-22M OT25	AM10	400	36650	260	140.9	42700	245

LUMINAIRE	OPTIC	LED CURRENT (mA)	RATED LUMINAIRE FLUX* (Tq=25°C, 5700K, lm)	RATED LUMINAIRE POWER* (Tq=25°C, Vin=230Vac, F, W)	LUMINAIRE EFFICACY (Tq=25°C, lm/W)	RATED LED FLUX* (Tj=85°C, 5700K, lm)	RATED LED POWER* (Tj=85°C, W)
ALO 1 2AB10 AM10 7057.450-22M OT25	AM10	450	40500	290	139.6	47600	275
ALO 1 2AB10 AM10 7057.500-22M OT25	AM10	500	44250	325	136.1	52400	310
ALO 1 2AB10 AM10 7057.550-22M OT25	AM10	550	47800	360	132.7	57100	345
ALO 1 2AB10 AM10 7057.600-22M OT25	AM10	600	51250	395	129.7	61700	380
ALO 1 2AB10 AM10 7057.650-22M OT25	AM10	650	54600	430	126.9	66200	415
ALO 1 2AB10 AM10 7057.700-22M OT25	AM10	700	57800	465	124.3	70700	450
ALO 1 2AB10 AM10 7057.750-22M OT25	AM10	750	60850	500	121.7	75100	485
ALO 1 2AB10 AM10 7057.800-22M OT25	AM10	800	63800	540	118.1	79400	520
ALO 1 2AB10 AM10 7057.825-22M OT25	AM10	825	65200	560	116.4	81500	535
ALO 1 2AB10 AM10 7057.350-22M ES OT25	AM10	350	29340	225	130.4	37700	210
ALO 1 2AB10 AM10 7057.400-22M ES OT25	AM10	400	32990	260	126.8	42700	245
ALO 1 2AB10 AM10 7057.450-22M ES OT25	AM10	450	36450	290	125.6	47600	275
ALO 1 2AB10 AM10 7057.500-22M ES OT25	AM10	500	39830	325	122.5	52400	310
ALO 1 2AB10 AM10 7057.550-22M ES OT25	AM10	550	43020	360	119.5	57100	345
ALO 1 2AB10 AM10 7057.600-22M ES OT25	AM10	600	46130	395	116.7	61700	380
ALO 1 2AB10 AM10 7057.650-22M ES OT25	AM10	650	49140	430	114.2	66200	415
ALO 1 2AB10 AM10 7057.700-22M ES OT25	AM10	700	52020	465	111.8	70700	450
ALO 1 2AB10 AM10 7057.750-22M ES OT25	AM10	750	54770	500	109.5	75100	485
ALO 1 2AB10 AM10 7057.800-22M ES OT25	AM10	800	57420	540	106.3	79400	520
ALO 1 2AB10 AM10 7057.825-22M ES OT25	AM10	825	58680	560	104.7	81500	535
ALO 1 2AB10 AN10 7057.350-22M OT25	AN10	350	33100	225	147.1	37700	210
ALO 1 2AB10 AN10 7057.400-22M OT25	AN10	400	37150	260	142.8	42700	245
ALO 1 2AB10 AN10 7057.450-22M OT25	AN10	450	41100	290	141.7	47600	275
ALO 1 2AB10 AN10 7057.500-22M OT25	AN10	500	44900	325	138.1	52400	310
ALO 1 2AB10 AN10 7057.550-22M OT25	AN10	550	48500	360	134.7	57100	345

LUMINAIRE	OPTIC	LED CURRENT (mA)	RATED LUMINAIRE FLUX* (Tq=25°C, 5700K, lm)	RATED LUMINAIRE POWER* (Tq=25°C, Vin=230Vac, F, W)	LUMINAIRE EFFICACY (Tq=25°C, lm/W)	RATED LED FLUX* (Tj=85°C, 5700K, lm)	RATED LED POWER* (Tj=85°C, W)
ALO 1 2AB10 AN10 7057.600-22M OT25	AN10	600	52000	395	131.6	61700	380
ALO 1 2AB10 AN10 7057.650-22M OT25	AN10	650	55400	430	128.8	66200	415
ALO 1 2AB10 AN10 7057.700-22M OT25	AN10	700	58650	465	126.1	70700	450
ALO 1 2AB10 AN10 7057.750-22M OT25	AN10	750	61750	500	123.5	75100	485
ALO 1 2AB10 AN10 7057.800-22M OT25	AN10	800	64750	540	119.9	79400	520
ALO 1 2AB10 AN10 7057.825-22M OT25	AN10	825	66200	560	118.2	81500	535
ALO 1 2AB10 AN10 7057.350-22M ES OT25	AN10	350	30450	225	135.3	37700	210
ALO 1 2AB10 AN10 7057.400-22M ES OT25	AN10	400	34180	260	131.4	42700	245
ALO 1 2AB10 AN10 7057.450-22M ES OT25	AN10	450	37810	290	130.3	47600	275
ALO 1 2AB10 AN10 7057.500-22M ES OT25	AN10	500	41310	325	127.1	52400	310
ALO 1 2AB10 AN10 7057.550-22M ES OT25	AN10	550	44620	360	123.9	57100	345
ALO 1 2AB10 AN10 7057.600-22M ES OT25	AN10	600	47840	395	121.1	61700	380
ALO 1 2AB10 AN10 7057.650-22M ES OT25	AN10	650	50970	430	118.5	66200	415
ALO 1 2AB10 AN10 7057.700-22M ES OT25	AN10	700	53960	465	116	70700	450
ALO 1 2AB10 AN10 7057.750-22M ES OT25	AN10	750	56810	500	113.6	75100	485
ALO 1 2AB10 AN10 7057.800-22M ES OT25	AN10	800	59570	540	110.3	79400	520
ALO 1 2AB10 AN10 7057.825-22M ES OT25	AN10	825	60900	560	108.7	81500	535
ALO 1 2AB10 ASM 7057.350-22M OT25	ASM	350	33250	225	147.7	37700	210
ALO 1 2AB10 ASM 7057.400-22M OT25	ASM	400	37350	260	143.6	42700	245
ALO 1 2AB10 ASM 7057.450-22M OT25	ASM	450	41300	290	142.4	47600	275
ALO 1 2AB10 ASM 7057.500-22M OT25	ASM	500	45100	325	138.7	52400	310
ALO 1 2AB10 ASM 7057.550-22M OT25	ASM	550	48750	360	135.4	57100	345
ALO 1 2AB10 ASM 7057.600-22M OT25	ASM	600	52250	395	132.2	61700	380
ALO 1 2AB10 ASM 7057.650-22M OT25	ASM	650	55650	430	129.4	66200	415
ALO 1 2AB10 ASM 7057.700-22M OT25	ASM	700	58900	465	126.6	70700	450

LUMINAIRE	OPTIC	LED CURRENT (mA)	RATED LUMINAIRE FLUX* (Tq=25°C, 5700K, lm)	RATED LUMINAIRE POWER* (Tq=25°C, Vin=230Vac, F, W)	LUMINAIRE EFFICACY (Tq=25°C, lm/W)	RATED LED FLUX* (Tj=85°C, 5700K, lm)	RATED LED POWER* (Tj=85°C, W)
ALO 1 2AB10 ASM 7057.750-22M OT25	ASM	750	62000	500	124	75100	485
ALO 1 2AB10 ASM 7057.800-22M OT25	ASM	800	65000	540	120.3	79400	520
ALO 1 2AB10 ASM 7057.825-22M OT25	ASM	825	66450	560	118.6	81500	535
ALO 1 2AB10 ASM 7057.350-22M ES OT25	ASM	350	31260	225	138.9	37700	210
ALO 1 2AB10 ASM 7057.400-22M ES OT25	ASM	400	35110	260	135	42700	245
ALO 1 2AB10 ASM 7057.450-22M ES OT25	ASM	450	38820	290	133.8	47600	275
ALO 1 2AB10 ASM 7057.500-22M ES OT25	ASM	500	42390	325	130.4	52400	310
ALO 1 2AB10 ASM 7057.550-22M ES OT25	ASM	550	45830	360	127.3	57100	345
ALO 1 2AB10 ASM 7057.600-22M ES OT25	ASM	600	49120	395	124.3	61700	380
ALO 1 2AB10 ASM 7057.650-22M ES OT25	ASM	650	52310	430	121.6	66200	415
ALO 1 2AB10 ASM 7057.700-22M ES OT25	ASM	700	55370	465	119	70700	450
ALO 1 2AB10 ASM 7057.750-22M ES OT25	ASM	750	58280	500	116.5	75100	485
ALO 1 2AB10 ASM 7057.800-22M ES OT25	ASM	800	61100	540	113.1	79400	520
ALO 1 2AB10 ASM 7057.825-22M ES OT25	ASM	825	62460	560	111.5	81500	535
ALO 1 2AB10 ASN 7057.350-22M OT25	ASN	350	32800	225	145.7	37700	210
ALO 1 2AB10 ASN 7057.400-22M OT25	ASN	400	36850	260	141.7	42700	245
ALO 1 2AB10 ASN 7057.450-22M OT25	ASN	450	40750	290	140.5	47600	275
ALO 1 2AB10 ASN 7057.500-22M OT25	ASN	500	44500	325	136.9	52400	310
ALO 1 2AB10 ASN 7057.550-22M OT25	ASN	550	48100	360	133.6	57100	345
ALO 1 2AB10 ASN 7057.600-22M OT25	ASN	600	51550	395	130.5	61700	380
ALO 1 2AB10 ASN 7057.650-22M OT25	ASN	650	54900	430	127.6	66200	415
ALO 1 2AB10 ASN 7057.700-22M OT25	ASN	700	58100	465	124.9	70700	450
ALO 1 2AB10 ASN 7057.750-22M OT25	ASN	750	61200	500	122.4	75100	485
ALO 1 2AB10 ASN 7057.800-22M OT25	ASN	800	64150	540	118.7	79400	520
ALO 1 2AB10 ASN 7057.825-22M OT25	ASN	825	65600	560	117.1	81500	535

LUMINAIRE	OPTIC	LED CURRENT (mA)	RATED LUMINAIRE FLUX* (Tq=25°C, 5700K, lm)	RATED LUMINAIRE POWER* (Tq=25°C, Vin=230Vac, F, W)	LUMINAIRE EFFICACY (Tq=25°C, lm/W)	RATED LED FLUX* (Tj=85°C, 5700K, lm)	RATED LED POWER* (Tj=85°C, W)
ALO 1 2AB10 ASN 7057.350-22M ES OT25	ASN	350	31160	225	138.4	37700	210
ALO 1 2AB10 ASN 7057.400-22M ES OT25	ASN	400	35010	260	134.6	42700	245
ALO 1 2AB10 ASN 7057.450-22M ES OT25	ASN	450	38710	290	133.4	47600	275
ALO 1 2AB10 ASN 7057.500-22M ES OT25	ASN	500	42280	325	130	52400	310
ALO 1 2AB10 ASN 7057.550-22M ES OT25	ASN	550	45700	360	126.9	57100	345
ALO 1 2AB10 ASN 7057.600-22M ES OT25	ASN	600	48970	395	123.9	61700	380
ALO 1 2AB10 ASN 7057.650-22M ES OT25	ASN	650	52160	430	121.3	66200	415
ALO 1 2AB10 ASN 7057.700-22M ES OT25	ASN	700	55200	465	118.7	70700	450
ALO 1 2AB10 ASN 7057.750-22M ES OT25	ASN	750	58140	500	116.2	75100	485
ALO 1 2AB10 ASN 7057.800-22M ES OT25	ASN	800	60940	540	112.8	79400	520
ALO 1 2AB10 ASN 7057.825-22M ES OT25	ASN	825	62320	560	111.2	81500	535
ALO 1 2AB10 ASW 7057.350-22M OT25	ASW	350	32750	225	145.5	37700	210
ALO 1 2AB10 ASW 7057.400-22M OT25	ASW	400	36750	260	141.3	42700	245
ALO 1 2AB10 ASW 7057.450-22M OT25	ASW	450	40650	290	140.1	47600	275
ALO 1 2AB10 ASW 7057.500-22M OT25	ASW	500	44400	325	136.6	52400	310
ALO 1 2AB10 ASW 7057.550-22M OT25	ASW	550	48000	360	133.3	57100	345
ALO 1 2AB10 ASW 7057.600-22M OT25	ASW	600	51450	395	130.2	61700	380
ALO 1 2AB10 ASW 7057.650-22M OT25	ASW	650	54750	430	127.3	66200	415
ALO 1 2AB10 ASW 7057.700-22M OT25	ASW	700	57950	465	124.6	70700	450
ALO 1 2AB10 ASW 7057.750-22M OT25	ASW	750	61050	500	122.1	75100	485
ALO 1 2AB10 ASW 7057.800-22M OT25	ASW	800	64000	540	118.5	79400	520
ALO 1 2AB10 ASW 7057.825-22M OT25	ASW	825	65450	560	116.8	81500	535
ALO 1 2AB10 ASW 7057.350-22M ES OT25	ASW	350	31110	225	138.2	37700	210
ALO 1 2AB10 ASW 7057.400-22M ES OT25	ASW	400	34910	260	134.2	42700	245
ALO 1 2AB10 ASW 7057.450-22M ES OT25	ASW	450	38620	290	133.1	47600	275

LUMINAIRE	OPTIC	LED CURRENT (mA)	RATED LUMINAIRE FLUX* (Tq=25°C, 5700K, lm)	RATED LUMINAIRE POWER* (Tq=25°C, Vin=230Vac, F, W)	LUMINAIRE EFFICACY (Tq=25°C, lm/W)	RATED LED FLUX* (Tj=85°C, 5700K, lm)	RATED LED POWER* (Tj=85°C, W)
ALO 1 2AB10 ASW 7057.500-22M ES OT25	ASW	500	42180	325	129.7	52400	310
ALO 1 2AB10 ASW 7057.550-22M ES OT25	ASW	550	45600	360	126.6	57100	345
ALO 1 2AB10 ASW 7057.600-22M ES OT25	ASW	600	48880	395	123.7	61700	380
ALO 1 2AB10 ASW 7057.650-22M ES OT25	ASW	650	52010	430	120.9	66200	415
ALO 1 2AB10 ASW 7057.700-22M ES OT25	ASW	700	55050	465	118.3	70700	450
ALO 1 2AB10 ASW 7057.750-22M ES OT25	ASW	750	58000	500	116	75100	485
ALO 1 2AB10 ASW 7057.800-22M ES OT25	ASW	800	60800	540	112.5	79400	520
ALO 1 2AB10 ASW 7057.825-22M ES OT25	ASW	825	62180	560	111	81500	535
ALO 1 2AB10 AW10 7057.350-22M OT25	AW10	350	32800	225	145.7	37700	210
ALO 1 2AB10 AW10 7057.400-22M OT25	AW10	400	36800	260	141.5	42700	245
ALO 1 2AB10 AW10 7057.450-22M OT25	AW10	450	40700	290	140.3	47600	275
ALO 1 2AB10 AW10 7057.500-22M OT25	AW10	500	44450	325	136.7	52400	310
ALO 1 2AB10 AW10 7057.550-22M OT25	AW10	550	48050	360	133.4	57100	345
ALO 1 2AB10 AW10 7057.600-22M OT25	AW10	600	51500	395	130.3	61700	380
ALO 1 2AB10 AW10 7057.650-22M OT25	AW10	650	54850	430	127.5	66200	415
ALO 1 2AB10 AW10 7057.700-22M OT25	AW10	700	58050	465	124.8	70700	450
ALO 1 2AB10 AW10 7057.750-22M OT25	AW10	750	61100	500	122.2	75100	485
ALO 1 2AB10 AW10 7057.800-22M OT25	AW10	800	64050	540	118.6	79400	520
ALO 1 2AB10 AW10 7057.825-22M OT25	AW10	825	65500	560	116.9	81500	535
ALO 1 2AB10 AW10 7057.350-22M ES OT25	AW10	350	29850	225	132.6	37700	210
ALO 1 2AB10 AW10 7057.400-22M ES OT25	AW10	400	33490	260	128.8	42700	245
ALO 1 2AB10 AW10 7057.450-22M ES OT25	AW10	450	37040	290	127.7	47600	275
ALO 1 2AB10 AW10 7057.500-22M ES OT25	AW10	500	40450	325	124.4	52400	310
ALO 1 2AB10 AW10 7057.550-22M ES OT25	AW10	550	43730	360	121.4	57100	345
ALO 1 2AB10 AW10 7057.600-22M ES OT25	AW10	600	46870	395	118.6	61700	380

LUMINAIRE	OPTIC	LED CURRENT (mA)	RATED LUMINAIRE FLUX* (Tq=25°C, 5700K, lm)	RATED LUMINAIRE POWER* (Tq=25°C, Vin=230Vac, F, W)	LUMINAIRE EFFICACY (Tq=25°C, lm/W)	RATED LED FLUX* (Tj=85°C, 5700K, lm)	RATED LED POWER* (Tj=85°C, W)
ALO 1 2AB10 AW10 7057.650-22M ES OT25	AW10	650	49910	430	116	66200	415
ALO 1 2AB10 AW10 7057.700-22M ES OT25	AW10	700	52830	465	113.6	70700	450
ALO 1 2AB10 AW10 7057.750-22M ES OT25	AW10	750	55600	500	111.2	75100	485
ALO 1 2AB10 AW10 7057.800-22M ES OT25	AW10	800	58290	540	107.9	79400	520
ALO 1 2AB10 AW10 7057.825-22M ES OT25	AW10	825	59610	560	106.4	81500	535
ALO 1 2AB10 BAC 7057.350-22M OT25	BAC	350	32400	225	144	37700	210
ALO 1 2AB10 BAC 7057.400-22M OT25	BAC	400	36400	260	140	42700	245
ALO 1 2AB10 BAC 7057.450-22M OT25	BAC	450	40200	290	138.6	47600	275
ALO 1 2AB10 BAC 7057.500-22M OT25	BAC	500	43900	325	135	52400	310
ALO 1 2AB10 BAC 7057.550-22M OT25	BAC	550	47500	360	131.9	57100	345
ALO 1 2AB10 BAC 7057.600-22M OT25	BAC	600	50900	395	128.8	61700	380
ALO 1 2AB10 BAC 7057.650-22M OT25	BAC	650	54200	430	126	66200	415
ALO 1 2AB10 BAC 7057.700-22M OT25	BAC	700	57350	465	123.3	70700	450
ALO 1 2AB10 BAC 7057.750-22M OT25	BAC	750	60400	500	120.8	75100	485
ALO 1 2AB10 BAC 7057.800-22M OT25	BAC	800	63350	540	117.3	79400	520
ALO 1 2AB10 BAC 7057.825-22M OT25	BAC	825	64750	560	115.6	81500	535
ALO 1 2AB10 BAC 7057.350-22M ES OT25	BAC	350	29810	225	132.4	37700	210
ALO 1 2AB10 BAC 7057.400-22M ES OT25	BAC	400	33490	260	128.8	42700	245
ALO 1 2AB10 BAC 7057.450-22M ES OT25	BAC	450	36980	290	127.5	47600	275
ALO 1 2AB10 BAC 7057.500-22M ES OT25	BAC	500	40390	325	124.2	52400	310
ALO 1 2AB10 BAC 7057.550-22M ES OT25	BAC	550	43700	360	121.3	57100	345
ALO 1 2AB10 BAC 7057.600-22M ES OT25	BAC	600	46830	395	118.5	61700	380
ALO 1 2AB10 BAC 7057.650-22M ES OT25	BAC	650	49860	430	115.9	66200	415
ALO 1 2AB10 BAC 7057.700-22M ES OT25	BAC	700	52760	465	113.4	70700	450
ALO 1 2AB10 BAC 7057.750-22M ES OT25	BAC	750	55570	500	111.1	75100	485

LUMINAIRE	OPTIC	LED CURRENT (mA)	RATED LUMINAIRE FLUX* (Tq=25°C, 5700K, lm)	RATED LUMINAIRE POWER* (Tq=25°C, Vin=230Vac, F, W)	LUMINAIRE EFFICACY (Tq=25°C, lm/W)	RATED LED FLUX* (Tj=85°C, 5700K, lm)	RATED LED POWER* (Tj=85°C, W)
ALO 1 2AB10 BAC 7057.800-22M ES OT25	BAC	800	58280	540	107.9	79400	520
ALO 1 2AB10 BAC 7057.825-22M ES OT25	BAC	825	59570	560	106.3	81500	535
ALO 1 2AB10 BAL 7057.350-22M OT25	BAL	350	32800	225	145.7	37700	210
ALO 1 2AB10 BAL 7057.400-22M OT25	BAL	400	36850	260	141.7	42700	245
ALO 1 2AB10 BAL 7057.450-22M OT25	BAL	450	40750	290	140.5	47600	275
ALO 1 2AB10 BAL 7057.500-22M OT25	BAL	500	44450	325	136.7	52400	310
ALO 1 2AB10 BAL 7057.550-22M OT25	BAL	550	48100	360	133.6	57100	345
ALO 1 2AB10 BAL 7057.600-22M OT25	BAL	600	51550	395	130.5	61700	380
ALO 1 2AB10 BAL 7057.650-22M OT25	BAL	650	54900	430	127.6	66200	415
ALO 1 2AB10 BAL 7057.700-22M OT25	BAL	700	58100	465	124.9	70700	450
ALO 1 2AB10 BAL 7057.750-22M OT25	BAL	750	61150	500	122.3	75100	485
ALO 1 2AB10 BAL 7057.800-22M OT25	BAL	800	64150	540	118.7	79400	520
ALO 1 2AB10 BAL 7057.825-22M OT25	BAL	825	65550	560	117	81500	535
ALO 1 2AB10 BAL 7057.350-22M ES OT25	BAL	350	30180	225	134.1	37700	210
ALO 1 2AB10 BAL 7057.400-22M ES OT25	BAL	400	33900	260	130.3	42700	245
ALO 1 2AB10 BAL 7057.450-22M ES OT25	BAL	450	37490	290	129.2	47600	275
ALO 1 2AB10 BAL 7057.500-22M ES OT25	BAL	500	40890	325	125.8	52400	310
ALO 1 2AB10 BAL 7057.550-22M ES OT25	BAL	550	44250	360	122.9	57100	345
ALO 1 2AB10 BAL 7057.600-22M ES OT25	BAL	600	47430	395	120	61700	380
ALO 1 2AB10 BAL 7057.650-22M ES OT25	BAL	650	50510	430	117.4	66200	415
ALO 1 2AB10 BAL 7057.700-22M ES OT25	BAL	700	53450	465	114.9	70700	450
ALO 1 2AB10 BAL 7057.750-22M ES OT25	BAL	750	56260	500	112.5	75100	485
ALO 1 2AB10 BAL 7057.800-22M ES OT25	BAL	800	59020	540	109.2	79400	520
ALO 1 2AB10 BAL 7057.825-22M ES OT25	BAL	825	60310	560	107.6	81500	535
ALO 1 2AB10 BAR 7057.350-22M OT25	BAR	350	32850	225	146	37700	210

LUMINAIRE	OPTIC	LED CURRENT (mA)	RATED LUMINAIRE FLUX* (Tq=25°C, 5700K, lm)	RATED LUMINAIRE POWER* (Tq=25°C, Vin=230Vac, F, W)	LUMINAIRE EFFICACY (Tq=25°C, lm/W)	RATED LED FLUX* (Tj=85°C, 5700K, lm)	RATED LED POWER* (Tj=85°C, W)
ALO 1 2AB10 BAR 7057.400-22M OT25	BAR	400	36900	260	141.9	42700	245
ALO 1 2AB10 BAR 7057.450-22M OT25	BAR	450	40750	290	140.5	47600	275
ALO 1 2AB10 BAR 7057.500-22M OT25	BAR	500	44550	325	137	52400	310
ALO 1 2AB10 BAR 7057.550-22M OT25	BAR	550	48150	360	133.7	57100	345
ALO 1 2AB10 BAR 7057.600-22M OT25	BAR	600	51600	395	130.6	61700	380
ALO 1 2AB10 BAR 7057.650-22M OT25	BAR	650	54950	430	127.7	66200	415
ALO 1 2AB10 BAR 7057.700-22M OT25	BAR	700	58150	465	125	70700	450
ALO 1 2AB10 BAR 7057.750-22M OT25	BAR	750	61250	500	122.5	75100	485
ALO 1 2AB10 BAR 7057.800-22M OT25	BAR	800	64200	540	118.8	79400	520
ALO 1 2AB10 BAR 7057.825-22M OT25	BAR	825	65650	560	117.2	81500	535
ALO 1 2AB10 BAR 7057.350-22M ES OT25	BAR	350	30220	225	134.3	37700	210
ALO 1 2AB10 BAR 7057.400-22M ES OT25	BAR	400	33950	260	130.5	42700	245
ALO 1 2AB10 BAR 7057.450-22M ES OT25	BAR	450	37490	290	129.2	47600	275
ALO 1 2AB10 BAR 7057.500-22M ES OT25	BAR	500	40990	325	126.1	52400	310
ALO 1 2AB10 BAR 7057.550-22M ES OT25	BAR	550	44300	360	123	57100	345
ALO 1 2AB10 BAR 7057.600-22M ES OT25	BAR	600	47470	395	120.1	61700	380
ALO 1 2AB10 BAR 7057.650-22M ES OT25	BAR	650	50550	430	117.5	66200	415
ALO 1 2AB10 BAR 7057.700-22M ES OT25	BAR	700	53500	465	115	70700	450
ALO 1 2AB10 BAR 7057.750-22M ES OT25	BAR	750	56350	500	112.7	75100	485
ALO 1 2AB10 BAR 7057.800-22M ES OT25	BAR	800	59060	540	109.3	79400	520
ALO 1 2AB10 BAR 7057.825-22M ES OT25	BAR	825	60400	560	107.8	81500	535
ALO 1 2AB10 SP15 7057.350-22M OT25	SP15	350	33600	225	149.3	37700	210
ALO 1 2AB10 SP15 7057.400-22M OT25	SP15	400	37750	260	145.1	42700	245
ALO 1 2AB10 SP15 7057.450-22M OT25	SP15	450	41750	290	143.9	47600	275
ALO 1 2AB10 SP15 7057.500-22M OT25	SP15	500	45600	325	140.3	52400	310

LUMINAIRE	OPTIC	LED CURRENT (mA)	RATED LUMINAIRE FLUX* (Tq=25°C, 5700K, lm)	RATED LUMINAIRE POWER* (Tq=25°C, Vin=230Vac, F, W)	LUMINAIRE EFFICACY (Tq=25°C, lm/W)	RATED LED FLUX* (Tj=85°C, 5700K, lm)	RATED LED POWER* (Tj=85°C, W)
ALO 1 2AB10 SP15 7057.550-22M OT25	SP15	550	49300	360	136.9	57100	345
ALO 1 2AB10 SP15 7057.600-22M OT25	SP15	600	52850	395	133.7	61700	380
ALO 1 2AB10 SP15 7057.650-22M OT25	SP15	650	56250	430	130.8	66200	415
ALO 1 2AB10 SP15 7057.700-22M OT25	SP15	700	59550	465	128	70700	450
ALO 1 2AB10 SP15 7057.750-22M OT25	SP15	750	62700	500	125.4	75100	485
ALO 1 2AB10 SP15 7057.800-22M OT25	SP15	800	65750	540	121.7	79400	520
ALO 1 2AB10 SP15 7057.825-22M OT25	SP15	825	67200	560	120	81500	535
ALO 1 2AB10 SP25 7057.350-22M OT25	SP25	350	33600	225	149.3	37700	210
ALO 1 2AB10 SP25 7057.400-22M OT25	SP25	400	37750	260	145.1	42700	245
ALO 1 2AB10 SP25 7057.450-22M OT25	SP25	450	41750	290	143.9	47600	275
ALO 1 2AB10 SP25 7057.500-22M OT25	SP25	500	45600	325	140.3	52400	310
ALO 1 2AB10 SP25 7057.550-22M OT25	SP25	550	49300	360	136.9	57100	345
ALO 1 2AB10 SP25 7057.600-22M OT25	SP25	600	52850	395	133.7	61700	380
ALO 1 2AB10 SP25 7057.650-22M OT25	SP25	650	56250	430	130.8	66200	415
ALO 1 2AB10 SP25 7057.700-22M OT25	SP25	700	59550	465	128	70700	450
ALO 1 2AB10 SP25 7057.750-22M OT25	SP25	750	62700	500	125.4	75100	485
ALO 1 2AB10 SP25 7057.800-22M OT25	SP25	800	65750	540	121.7	79400	520
ALO 1 2AB10 SP25 7057.825-22M OT25	SP25	825	67200	560	120	81500	535
ALO 1 2AB10 SP40 7057.350-22M OT25	SP40	350	33300	225	148	37700	210
ALO 1 2AB10 SP40 7057.400-22M OT25	SP40	400	37400	260	143.8	42700	245
ALO 1 2AB10 SP40 7057.450-22M OT25	SP40	450	41300	290	142.4	47600	275
ALO 1 2AB10 SP40 7057.500-22M OT25	SP40	500	45150	325	138.9	52400	310
ALO 1 2AB10 SP40 7057.550-22M OT25	SP40	550	48800	360	135.5	57100	345
ALO 1 2AB10 SP40 7057.600-22M OT25	SP40	600	52300	395	132.4	61700	380
ALO 1 2AB10 SP40 7057.650-22M OT25	SP40	650	55700	430	129.5	66200	415

LUMINAIRE	OPTIC	LED CURRENT (mA)	RATED LUMINAIRE FLUX* (Tq=25°C, 5700K, lm)	RATED LUMINAIRE POWER* (Tq=25°C, Vin=230Vac, F, W)	LUMINAIRE EFFICACY (Tq=25°C, lm/W)	RATED LED FLUX* (Tj=85°C, 5700K, lm)	RATED LED POWER* (Tj=85°C, W)
ALO 1 2AB10 SP40 7057.700-22M OT25	SP40	700	58950	465	126.7	70700	450
ALO 1 2AB10 SP40 7057.750-22M OT25	SP40	750	62050	500	124.1	75100	485
ALO 1 2AB10 SP40 7057.800-22M OT25	SP40	800	65050	540	120.4	79400	520
ALO 1 2AB10 SP40 7057.825-22M OT25	SP40	825	66550	560	118.8	81500	535
ALO 1 2AB10 SP55 7057.350-22M OT25	SP55	350	30350	225	134.8	37700	210
ALO 1 2AB10 SP55 7057.400-22M OT25	SP55	400	34100	260	131.1	42700	245
ALO 1 2AB10 SP55 7057.450-22M OT25	SP55	450	37700	290	130	47600	275
ALO 1 2AB10 SP55 7057.500-22M OT25	SP55	500	41200	325	126.7	52400	310
ALO 1 2AB10 SP55 7057.550-22M OT25	SP55	550	44500	360	123.6	57100	345
ALO 1 2AB10 SP55 7057.600-22M OT25	SP55	600	47750	395	120.8	61700	380
ALO 1 2AB10 SP55 7057.650-22M OT25	SP55	650	50800	430	118.1	66200	415
ALO 1 2AB10 SP55 7057.700-22M OT25	SP55	700	53800	465	115.6	70700	450
ALO 1 2AB10 SP55 7057.750-22M OT25	SP55	750	56650	500	113.3	75100	485
ALO 1 2AB10 SP55 7057.800-22M OT25	SP55	800	59400	540	110	79400	520
ALO 1 2AB10 SP55 7057.825-22M OT25	SP55	825	60700	560	108.3	81500	535

*RATED LUMINAIRE FLUX / RATED LUMINAIRE POWER: Rated data obtained in laboratory.

*RATED LED FLUX / RATED LED POWER: Rated data extrapolated from LED manufacturer datasheet.

Values indicated in this technical sheet are to be considered rated values. Flux tolerance: $\pm 7\%$. Power tolerance: $\pm 10\%$.

The characteristics of the product listed above are subjected to change without notice.

Performance data for other operating temperatures (OT) and other combinations of CRI and CCT available on request.

There may be current limitations depending on the operating temperature. See dedicated section on following pages.